

DELTA O-RING CARTRIDGE SEAL ASSEMBLY AND INSTALLATION INSTRUCTIONS



INTRODUCTION:

These instructions are provided to familiarize the user with the seal and its use. The instructions must be read carefully and applied whenever work is done on the seal. Please keep available for future reference.

IMPORTANT: These instructions are for the installation and operation of a seal as used in rotating equipment and will help to avoid danger and improve reliability. The information required may change with other types of equipment or installations. These instructions must be read in conjunction with the instruction manuals for both the pump and any auxiliary equipment.

If the seal is to be used for an application other than that originally intended or outside the recommended performance limits, Delta must be contacted before its installation and use.

Any warranty may be affected by improper handling, installation, or use of this seal. Contact the company for information as to product warranty and limitations of liability.

If questions or problems arise, contact your local Delta Sales/Service Engineer or the original equipment manufacturer, as needed.

IMPORTANT: Delta Mechanical Seals are precision products and must be handled appropriately. Take particular care to avoid damage to lapped sealing faces.

SAFETY NOTES:

1. The following designations are used in the installation instructions to highlight areas of particular importance:

NOTE: Refers to special information on how to install or operate the seal.

IMPORTANT: Refers to special information towards the prevention of damage to the seal or its surroundings.

WARNING: Refers to mandatory instructions designed to prevent personal injury or extensive damage.

- Installation, removal and maintenance of the seal must be carried out only by qualified personnel who have read and understood all instructions.
- The seal is designated exclusively for sealing rotating equipment; manufacturer cannot be held liable for use of the seal for purposes other than noted.
- The seal must only be used in perfect conditions and must be operated within the recommended performance limits in accordance with its designated use set out in these instructions for installation of Delta Mechanical Seals.
- If the fluid pumped is hazardous or toxic, special care and appropriate precautions must be taken to ensure that any seal leakage is adequately contained. Further information on sealing hazardous or toxic fluids is available from Delta and should be read carefully prior to seal installation.
- Fluorocarbon components should never be burned or incinerated as the fumes and residues are toxic. If fluorocarbons are accidentally heated above 700 degrees F they decompose, therefore, protective gloves should be worn as acid may be present.
- PTFE should never be burned or incinerated as the fumes are toxic and dangerous.

PRIOR TO STARTING EQUIPMENT:

- Check the pump at the coupling for proper alignment of the motor.
- Ensure that the gland nuts/bolts are securely tightened and that all screws are securely fastened.
- Complete the assembly of the pump and turn the shaft to ensure free rotation prior to startup.
- Consult all equipment operating instructions to check for proper piping and connections, particularly regarding: seal recirculation/flush, heating or cooling requirements, and external services.

IMPORTANT: This mechanical seal is designed to operate in a liquid so the heat created must be removed. The following check should be carried out after seal installation and after any period of equipment inactivity.

- Check that all seal chamber lines are open and free from obstruction and ensure that the seal chamber is properly vented and filled with liquid; refer to "Delta Start-up Procedures" and pump instruction manual.

IMPORTANT: Dry-running, often indicated by a squealing noise from the seal area, causes overheating and damage to the sealing surfaces, resulting in excessive leakage and shortened seal life.

WARNING: Before start-up, make sure all personnel and tools have been moved to a safe distance so there is no contact with rotating components on the pump, coupling, seal and motor.

WARNING: Seal installation should be handled only by qualified, trained personnel. If questions arise, contact the local Delta Engineer. Improper use or installation of this product could result in injury and/or harmful emissions to the environment, and may affect any warranty on the product. Please contact Delta for information as to exclusive product warranty and liability limitations.

AFTER EQUIPMENT HAS RUN:

- Make sure that the pump is electrically isolated.

WARNING: If the seal has been used on toxic or hazardous fluids, ensure that the seal is correctly decontaminated and safe prior to commencing work.

NOTE: Fluid is often trapped during draining and may exist outside the seal. The pump instruction manual should be consulted for any special precautions.

- Ensure that the pump is isolated by the appropriate valves. Check that the fluid is drained and pressure is fully released.
- Make sure work area is safe, secure, and well ventilated.

SEAL MAINTENANCE:

No maintenance of a seal is possible while installed; therefore, it is recommended that a spare seal (to prevent unnecessary downtime) be held in stock to allow immediate replacement of a removed seal.

WARNING: It is the responsibility of the user to ensure that any parts being sent to a third party have appropriate, safe-handling instructions externally attached to the mechanical seal packaging.

DELTA QUALITY ASSURANCE:

This seal has been assembled in accordance with Delta Quality Assurance Standards. With proper maintenance and use, it will give safe and reliable operation to the maximum recommended performance as shown in Delta publications.

SINGLE CARTRIDGE SEAL ASSEMBLY FOR STYLE 8000 SERIES

TOOLS REQUIRED: Allen wrench and special lubricant provided with seal or repair kit.
Additional tools: small screwdriver, paper clip or o-ring extractor.

NOTE: **Bold type below identifies components listed in "Seal Cutaway/Part Identification Key" on page 4.**

DISASSEMBLY:

1. Compress seal slightly and remove **snap ring**.
2. Loosen **set screws** and lift off **lock collar**.
3. Remove **sleeve** with **inboard rotary face** out of the **gland**.
4. Carefully remove the **inboard rotary face** from the **sleeve**.
5. Carefully remove the **inboard stationary face** from the **gland**. Do not damage seal faces.
6. Carefully remove **o-rings** from **position 1, position 2, and position 3**.
7. On seal model supplied with optional "**Exotic Metal Gland Insert**" (typically of Hastelloy "C", "B" or Titanium) remove insert and o-rings.
8. Remove the **springs** from the **gland**.
9. Replace **gasket** (some models use an o-ring in place of a gasket) if required, making sure the **gasket** is centered to **gland bore**. If seal model is supplied with "**Exotic Metal Gland Insert**", replace gasket on gland insert, centering it.
10. Place gland down on table with gasket surface down. If optional floating throttle bushing or lip seal is used, carefully remove **snap ring and throttle bushing or lip seal**.
11. Carefully remove **o-ring position 4**.
12. Carefully remove **o-ring position 6**.

ASSEMBLY:

13. Lubricate all o-rings with the special lubricant provided.
14. Install the **o-ring position 1** in the **sleeve I.D.**
15. Slide the **o-ring position 2** over the **inboard rotary face**.
16. Slide the **inboard rotary face** onto the **sleeve**, aligning the slot on the **inboard rotary face**, with the drive pin in the **sleeve**. Gently seat the **inboard rotary face** evenly, making sure the pin is engaged in the slot to avoid damaging the face.
17. Place new **springs** in the inboard **spring** holes located in the gland, (gasket side). Apply a small amount of special lubricant to the bottom of each **spring** which will help the **springs** stay in their holes during assembly.
18. If seal model was supplied with an optional "**Exotic Metal Gland Insert**" (typically Hastelloy "C", "B" or Titanium), install the o-ring around the insert and install the insert into the gland cavity.
19. Install the **o-ring position 3** over the shoulder, on the back side, of the **inboard stationary face**.
20. Install the **inboard stationary face** into the **gland**.

IMPORTANT: **On the surface of the inboard stationary face opposite the lapped surface are four slots. The two smaller square slots should be aligned over the anti-rotation lugs in the gland. The remaining two large slots must be aligned with the drilled thru holes located opposite of the drive lugs in the gland cavity.**

NOTE: Some models use an inboard stationary face which has four equally spaced identical slots. The four slots will be 90 degrees apart.

21. Clean both seal faces with denatured alcohol and a lint-free cloth.
22. Carefully slide the **sleeve**, with rotary installed, into the **gland** making sure the **sleeve** does not damage the **inboard stationary face**.
23. Place the seal on the table with the drilled thru holes in sleeve facing upwards.
24. Install the **o-ring position 4** over the nose (smallest O.D.) in the gland cavity.
25. If optional floating throttle bushing or lip seal is used, carefully install **floating throttle bushing or lip seal bushing then install snap ring**.

IMPORTANT: **Align the slots on the outside diameter of the bushing, with the two anti-rotation pins in the gland. Gently seat the throttle bushing or lip seal bushing, making sure the pins engage the slots.**

26. Install the **o-ring position 6** in the **lock collar I.D.**
27. Visually align the **lock collar set screws** with the drilled thru holes on the end of the sleeve, then evenly compress the **lock collar** assembly until the top of the **lock collar** is below the **snap ring groove** in the **sleeve**. Install the **snap ring**.

NOTE: Make sure the **set screws** do not protrude through the I.D. of the **lock collar** prior to compression.

28. Precisely align the **set screws** with the drilled thru holes in the **sleeve** and engage the **set screws** in the thru holes. Make sure the **set screws** do not protrude into the sleeve I.D. bore but they must engage the thru holes.
29. Install and re-tighten the centering clips. Make sure the clips are shouldered squarely on mating surface or in channel grooves, depending on seal style.

THE ASSEMBLY IS NOW COMPLETE

EQUIPMENT PREPARATION / INSTALLATION



SHAFT / SLEEVE EXAMINATION:

1. The shaft finish should be 30 micro inches RMS and feel smooth if you run your fingernail down it axially
2. Make sure the shaft or sleeve diameter is within + .001"/- .002" of nominal.
3. Use a dial indicator to measure the shaft runout in the area where the seal will be installed. (Readings should not exceed .002" TIR per inch or shaft diameter.)
4. Place the dial indicator on the end of the shaft and alternately push and pull the shaft axially to measure end play. End play should not exceed .005" TIR.
5. Protect the sleeve o-ring by lubricating the shaft with a clean silicone based lubricant.
6. A static o-ring (position 1) must seal to the shaft at the shown location. Be sure the shaft is clean and free from scratches within the o-ring area.
7. Remove all burrs and sharp corners, especially in areas where the o-ring has to slide. Cover threads and keyway slots to prevent cutting the o-ring during installation.

STUFFING BOX/SEAL CHAMBER EXAMINATION:

8. Check that the stuffing box/seal chamber is clean with no obstructions.
9. The stuffing box face should be a maximum of 125 micro inches RMS for proper gasket sealing.
10. Attach the dial indicator base to the shaft and rotate both the indicator and shaft while reading the runout of the stuffing box face. Misalignment of the stuffing box face relative to the shaft should not exceed .003" TIR per inch of shaft diameter.
11. Some split case pumps will have a misalignment between halves on the stuffing box face. This surface must be machined flat.

PUMP/DRIVER ALIGNMENT:

12. Check the driver shaft (motor) to equipment shaft (pump) alignment using a dial indicator or precision alignment procedure.

NOTE: If any values in the above steps are found to be out of tolerance, corrective actions must be taken to ensure extended seal life

INSTALLING THE SEAL:

1. Before starting the installation, read the following instructions carefully.
2. Remove the seal from its packaging, inspect for any damage, and wipe clean.
3. Verify that the metallurgy, faces, and o-rings are compatible with the fluid to be sealed.
4. The equipment should be cleaned and comply with the "Equipment Preparation" procedures.
5. Lubricate the o-ring in the sleeve with the special lubricant provided.
6. The set screws go into the small holes in the sleeve. Do not disengage these screws from the sleeve when positioning the seal. Make sure all screws are engaged in the sleeve but do not protrude into the I.D. bore. Also, when repositioning (ex: impeller adjustment) or removing the seal, make sure the three centering clips and socket head cap screws are seated and tightened securely.
7. If the seal is operating at stuffing box pressures above 250 PSI or if the shaft/sleeve is case hardened, replace the 316SS set screws with hardened steel cup point set screws.
8. The centering clips have been preset at the factory. If for any reason you loosen or remove the centering clip cap screws, re-tighten each cap screw firmly. Make sure the centering clips are shouldered squarely on mating surfaces or in channel grooves etc, depending on seal style.
9. Make sure the gasket is glued and centered to the gland bore.
10. Slide the seal onto the shaft by pushing on either the drive collar for horizontal split case pumps or the seal sleeve for ANSI back pull out pumps. Do not push on the gland! Make sure the set screws are engaged through the seal sleeve thru holes, but do not protrude into the sleeve I.D. bore.
11. Reassemble the pump making necessary shaft alignments and impeller adjustments. The impeller can be reset at any time, as long as the centering clips are securely in place and the seal set screws have been loosened only enough to allow the equipment shaft/sleeve to slide through the seal sleeve while the shaft is being moved.
12. Orient the piping connections per the instructions outlined in the "Gland Front View/Piping Arrangement" and "Piping Details" on page 4. Do not connect piping until after gland bolts/nuts have been tightened!
13. Tighten gland bolts/nuts in an alternate pattern until secure (1/4 turns 180 degrees apart). Make sure flat washers are used, failure to do so may cause the gland to move off center.
14. Perform a visual check after bolting to make sure the centering clips are shouldered squarely on gland mating surface, in channel grooves, etc. The gap between the lock collar and the gland should be uniform 360 degrees. If clips are not shouldered push the seal sleeve towards the gland as this should correct the problem.
15. Tighten lock collar set screws evenly 1/4 turns securing cartridge seal to shaft.
16. Remove socket head cap screws and centering clips and save for future use.
17. It is important to check that the sleeve is centered in the gland. To accomplish this turn the shaft by hand to make sure the seal turns freely. If you hear metal to metal contact within the seal, the seal must be re-centered. Replace the centering clips finger tight, loosen gland bolts/nuts, then tighten clips. Go back and perform steps 13 - 17. If metal to metal contact still exists, check the centering of the stuffing box to the shaft.
18. Piping connections can only be made after the gland bolts/nuts are securely tightened. (Steps 1-17 completed).
19. Make appropriate piping connections to the seal assembly and equipment. See "Gland Front View/Piping Arrangements" and "Piping Details", "Environmental Controls" on page 4.

WARNING: Take all necessary precautions and follow all safety procedures before starting the equipment!

TYPICAL STYLE 8020 SEAL ARRANGEMENT



Seal Cutaway

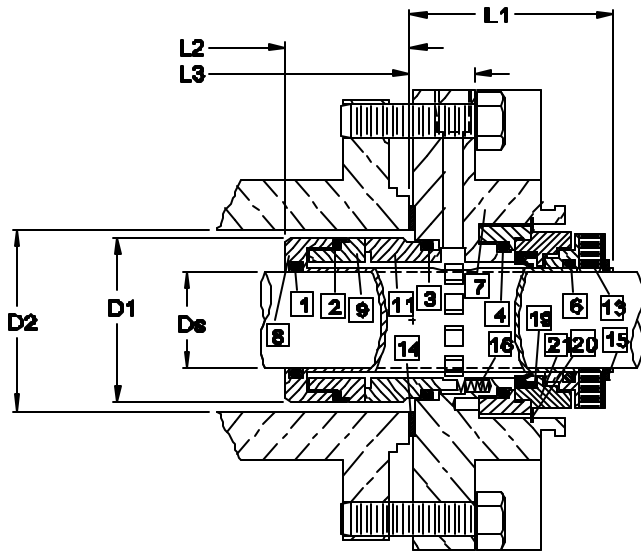

Seal Cutaway/Part Identification Key

Item	Description	Part Number
1	O-ring Pos.1	Standard
2	O-ring Pos.2	Standard
3	O-ring Pos.3	Standard
4	O-ring Pos.4	N/A
5	O-ring Pos.5	N/A
6	O-ring Pos.6	N/A
7	Gland	Standard
8	Sleeve	Standard
9	Inboard Rotary Face:	Standard
10	Outboard Rotary Face:	N/A
11	Inboard Stationary Face:	Standard
12	Outboard Stationary Face:	N/A
13	Set Screws / Lock Collar	Standard
14	Gasket	Standard
15	Snap Ring	Standard
16	Springs	Standard
17	Centering Clips	(Not Shown)
18		
19	Floating Throttle Bushing	Standard
20	Snap Ring	Standard
21	Lip Seal Bushing	Standard

Additional Products

Gland Front View / Piping Arrangement

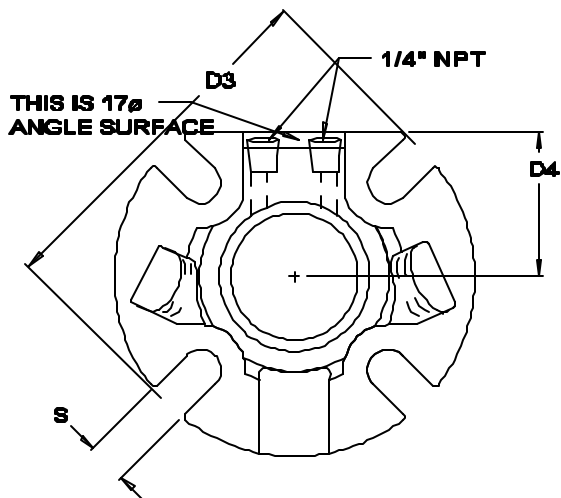

Direction of view is from the driver end of pump.

Suggested Environmental Controls

Piping Details

SINGLE CARTRIDGE SEALS MODEL 8000 SERIES WITH & WITHOUT QUENCH & DRAIN (FLOATING THROTTLE BUSHING OR LIP SEAL BUSHING DESIGN)

It is recommended that the seal cavity be vented through the pump's lantern ring connection located at top dead center available on some pump models. It is always recommended that a flush injection be utilized. The flush should be piped into the stuffing box/seal chamber. The exception is API Plan 02 (requires no circulation of flushed fluid)

WHEN FLUSHING FROM A HIGHER PRESSURE OR EXTERNAL SOURCE (EX: API PLAN 11, 12, 21, 22, 23, 31, 32, 41, 86, 97, 99):

GLAND HAS NO FLUSH PORT:

The gland has no flush ports, pipe into the stuffing box piping connections.

WHEN FLUSHING TO A LOWER PRESSURE SOURCE (EX: API PLAN 13, 85, 98):

GLAND HAS NO FLUSH PORT:

The gland has no flush ports, pipe into the stuffing box piping connections.

WHEN QUENCH AND DRAIN FEATURE IS USED:

Refer to information provided in "Suggested Environmental Controls" on page 4. The quench and drain connections should be located at 6 o'clock.

WHEN NO OPTIONAL FLOATING THROTTLE BUSHING OR LIP SEAL BUSHING IS USED.

NOTE: It is also recommended that an API Plan 13 (Delta's Plan 98 - Recirculation from pump case (suction) and back to stuffing box/seal chamber) or 11 (Delta's Plan 97 - Recirculation from pump case (discharge) and back to stuffing box/seal chamber) piped to the stuffing box/seal chamber connection be utilized.

PORTS CAN BE POSITIONED AT 12:00 O' CLOCK, 3:00 O'CLOCK, 6:00 O'CLOCK, OR 9:00 O'CLOCK, IT MAKES NO DIFFERENCE.

WHEN OPTIONAL LIP SEAL BUSHING DESIGN IS USED

NOTE: It is also recommended that an API Plan 13 (Delta's Plan 98 - Recirculation from pump case (suction) and back to stuffing box/seal chamber) or 11 (Delta's Plan 97 - Recirculation from pump case (discharge) and back to stuffing box/seal chamber) piped to the stuffing box/seal chamber connection be utilized.

PORTS POSITIONED AT 12:00 O' CLOCK (PREFERRED POSITION):

- **Clockwise shaft rotation:** The cool fluid, enters through the right port and the hot fluid exits the seal through the left port and goes out.
- **Counter-clockwise shaft rotation:** The cool fluid, enters through the left port and the hot fluid exits the seal through the right port and goes out.

PORTS POSITIONED ON RIGHT SIDE AT 3:00 O' CLOCK:

- **Clockwise shaft rotation:** The cool fluid, enters through the lower port and the hot fluid exits the seal through the upper port and goes out.

NOTE: We do not recommend ports be positioned at 3:00 o'clock for **counter-clockwise** shaft rotation.

PORTS POSITIONED ON LEFT SIDE AT 9:00:

- **Counter-clockwise shaft rotation:** The cool fluid enters through the upper port and the hot fluid exits the seal through the lower port and goes out.

NOTE: We do not recommend ports be positioned at 9:00 for **clockwise** shaft rotation.

NOTE: All rotations as viewed from driver end of pump.

WHEN OPTIONAL FLOATING THROTTLE BUSHING IS USED

NOTE: It is also recommended that an API Plan 13 (Delta's Plan 98 - Recirculation from pump case (suction) and back to stuffing box/seal chamber) or 11 (Delta's Plan 97 - Recirculation from pump case (discharge) and back to stuffing box/seal chamber) piped to the stuffing box/seal chamber connection be utilized.

PORTS POSITIONED AT 6:00 O'CLOCK (PREFERRED POSITION):

- **Clockwise shaft rotation:** The fluid/steam enters through the left port and exits through the right port.
- **Counter clockwise shaft rotation:** The fluid/steam enters through the right port and exits through the left port.

PORTS POSITIONED ON RIGHT SIDE 3:00 O' CLOCK:

- **Clockwise shaft rotation:** The fluid/steam enters through the lower port and exits through the upper port.
- **Counter clockwise rotation:** The fluid/steam enters through the upper port and exits through the lower port.

PORTS POSITIONED ON LEFT SIDE 9:00 O' CLOCK:

- **Clockwise shaft rotation:** The fluid/steam enters through the upper port and exits through the lower port.
- **Counter clockwise shaft rotation:** The fluid/steam enters through the lower port and exits through the upper port.

NOTE: All rotations as viewed from driver end of pump.

WARNING: Take all necessary precautions and follow safety procedures before starting the equipment.

A flush is always recommended. Three types are commonly used:

Plan 98 (Modified API Plan 13)

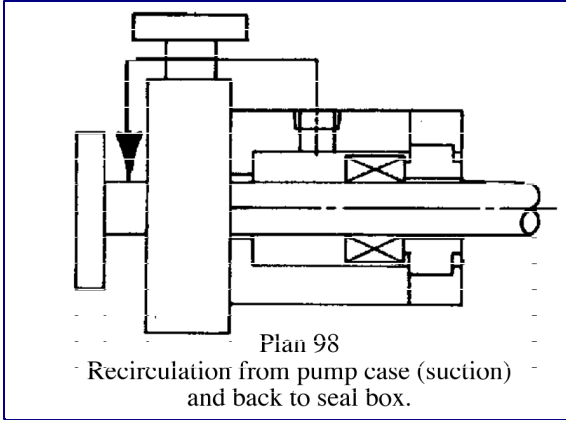

A line is connected from the pump suction to the stuffing box/seal chamber. This is used to reduce pressure in the seal chamber enabling the seal to run cooler and to recirculate liquid and solids away from the seal faces.

Plan 97 (Modified API Plan 11)

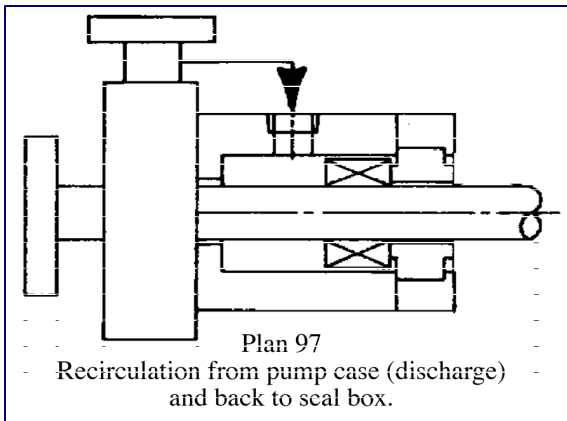

A line is connected from the pump discharge to the stuffing box/seal chamber. The pumped fluid used to flush the seal must be clean and at a temperature well below the product's vapor pressure at seal chamber temperature. In some cases where the product is near its initial boiling point at chamber pressure, the seal chamber pressure may be increased by installing a bushing in the throat of the chamber. This bushing will increase the seal chamber pressure and reduce damaging flashing and vaporization of the product at the seal faces.

Plan 99 (Modified API Plan 32)

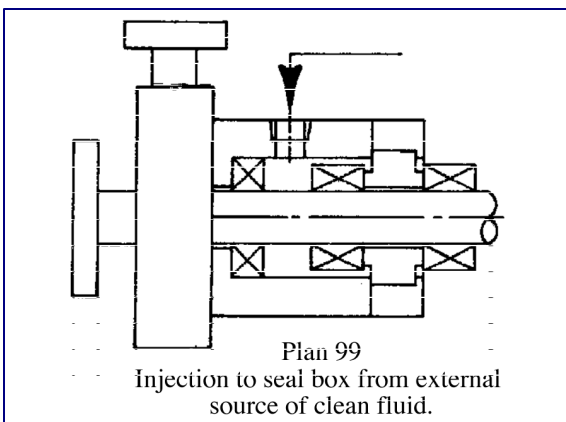

The stuffing box/seal chamber is flushed from a clean, cool external source at a rate and temperature to maintain a proper environment for the seal. The flush must be sufficient to prevent the pumped fluid from entering the seal chamber. A close clearance bushing installed in the bottom of the seal chamber will reduce the flush required by increasing the velocity at the throat at a given flow.

WARNING: TAKE ALL NECESSARY PRECAUTIONS AND FOLLOW SAFETY PROCEDURES BEFORE STARTING THE EQUIPMENT.

©1997 Delta Mechanical Seals. All rights reserved. Patent Pending